

公司简介

苏州康吉奥电子科技有限公司专注于电气电源领域的新技术研究，为客户提供电流线路连接的专业解决方案。

“康吉奥”提倡环保与节能，密切关注环保和新能源产业的发展，积极投入新能源产业的产品开发，已相继开发出适用于发电机组、动力电池、风电、LED照明等行业的连接器及相关配件。

“康吉奥”将紧跟时代与行业发展的步伐，为中国的环保节能事业做出不懈的努力，成为新能源连接器行业的领先者。



MA 系列防水连接器

MA 系列防水连接器规格齐全，芯数从 2 芯到 26 芯，电流从 5A 到 50A，并提供多种安装方式，可以满足各种需要，节约开发时间，适用于户外 LED 照明，LED 显示屏，伺服电源，机床，工业设备等各种使用场合。



主要特性

- ◇ 防护等级达到IP68
- ◇ 螺纹连接，带防松结构，安全可靠
- ◇ 多种安装方式及出线方式
- ◇ 外壳采用高性能塑料，满足各种恶劣的环境要求

IP68 Threaded coupling

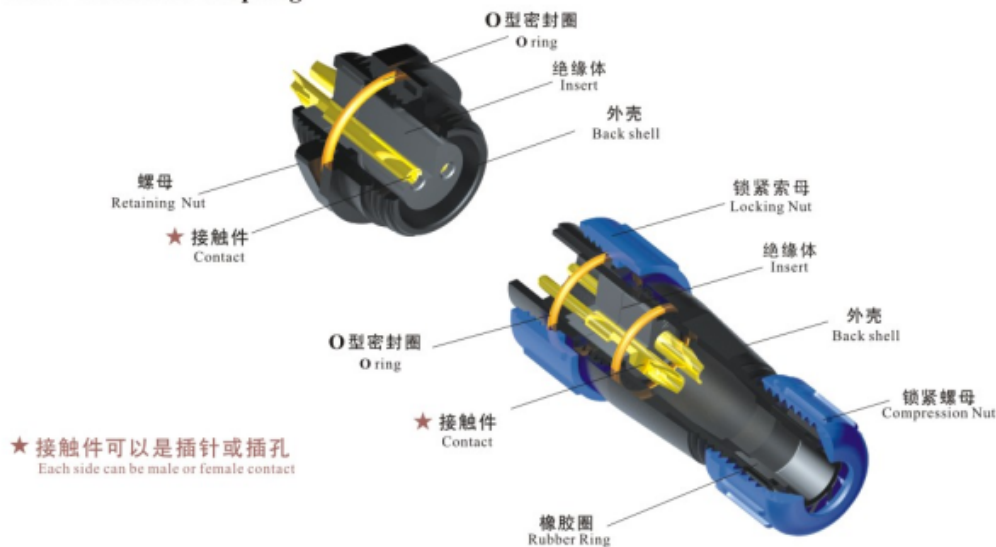



材料和技术参数

接插方式	Coupling	螺纹锁紧	Threaded coupling
外壳材料	Shell material	热塑塑料 PA66	Nylon66
绝缘体	Insert material	热塑塑料 PPS 耐高温 260°C	PPS max temperature 260°C
接触件材料	Contact material	铜合金（镀银/镀金）	Brass with gold/silver plating
接线方式	Termination	焊接	Solder
防护等级	IP rating	IP68	
接插次数	Mating cycle	500	
温度范围	Temperature range	-25°C ~ +85°C	
额定电压 AC.V	Rated voltage	500	
耐压 1min AC.V	Test voltage	1500	
绝缘电阻 MΩ	Insulation resistance	2000	

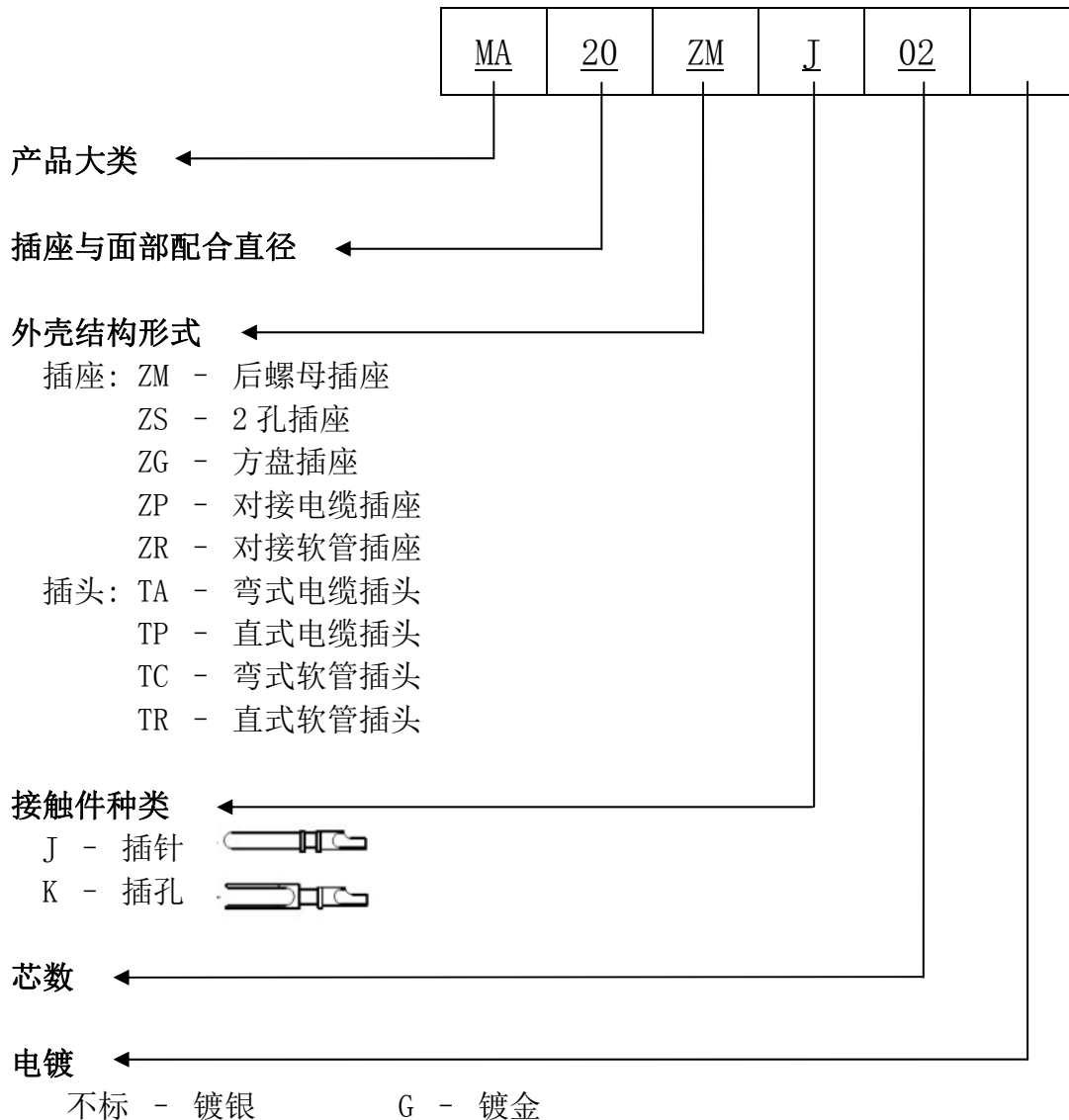
产品系列及选型说明

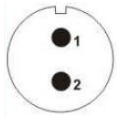

芯数排列及技术特性表

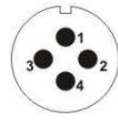
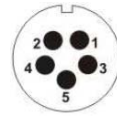
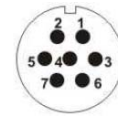
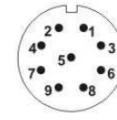
MA16	02	03	04	05	07	09
插针绝缘体正面 Male contact face view						
额定电流 (A) Rated current (A)	15	15	5	5	5	5
接触件直径 Contact diameter	∅1.8×2	∅1.8×3	∅1×4	∅1×5	∅1×7	∅1×9
接触电阻 (mΩ) Contact resistance	2	2	5	5	5	5

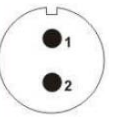
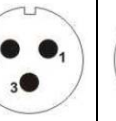
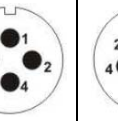
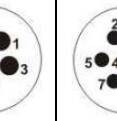
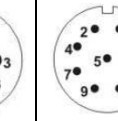
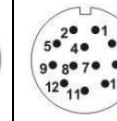
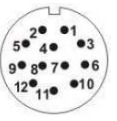
MA20	02	03	04	05	07	09	12
插针绝缘体正面 Male contact face view							
额定电流 (A) Rated current (A)	25	25	25	25	10	5	5
接触件直径 Contact diameter	∅2.8×2	∅2.8×3	∅2.8×4	∅2.8×5	∅1.8×7	∅1×9	∅1×12
接触电阻 (mΩ) Contact resistance	1	1	1	1	2	5	5

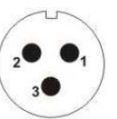
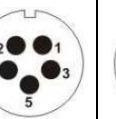
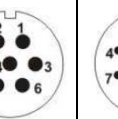
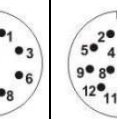
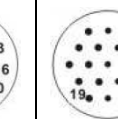
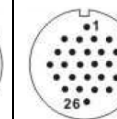
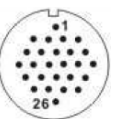
MA28	03	05	07	09	12	19	26
插针绝缘体正面 Male contact face view							
额定电流 (A) Rated current (A)	50	25	25	10	10	5	5
接触件直径 Contact diameter	∅2.8×2	∅2.8×5	∅2.8×7	∅1.8×9	∅1.8×12	∅1×19	∅1×26
接触电阻 (mΩ) Contact resistance	1	1	1	2	2	5	5

外形及安装尺寸

MA16 系列

插座 Receptacle

后螺母插座: ZM

Round flange panel receptacle: ZM

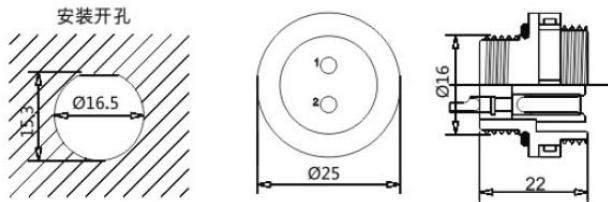

2 孔法兰插座: ZS

2-hole flange receptacle: ZS

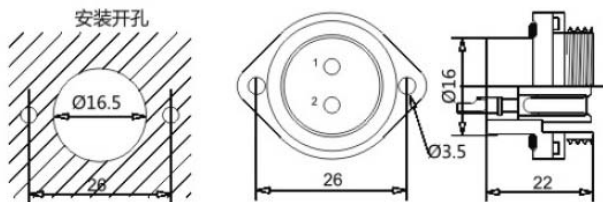

方盘法兰插座: ZG

Square flange panel receptacle: ZG

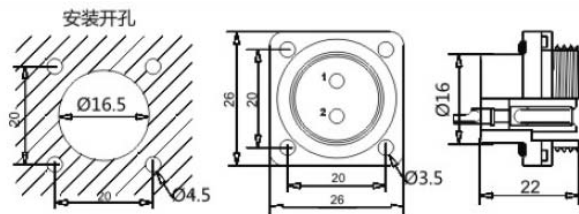

电缆对接插座: ZP

In-line cable receptacle with hose gland: ZP

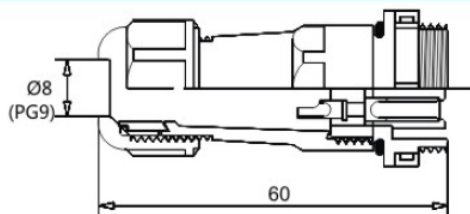

插头 Plug

直式电缆插头: TP

Straight plug cable gland: TP

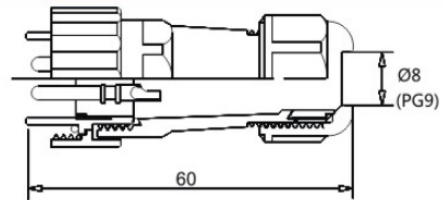

直式软管插头: TR

Straight plug hose gland: TR

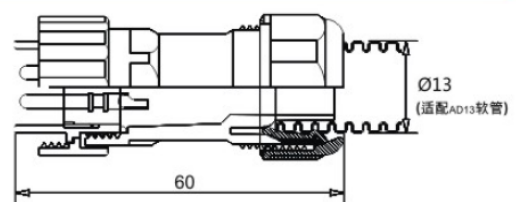

直式软管插座: ZR

In-line cable receptacle with cable gland: ZR

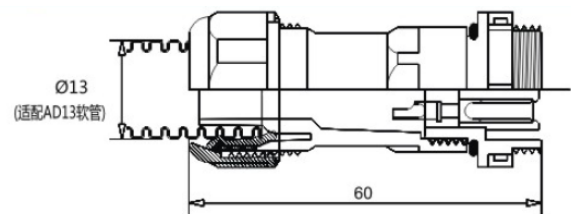

MA20 系列

插座 Receptacle

后螺母插座: ZM

Round flange panel receptacle: ZM

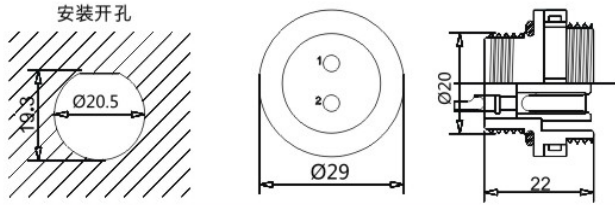

2 孔法兰插座: ZS

2-hole flange receptacle: ZS

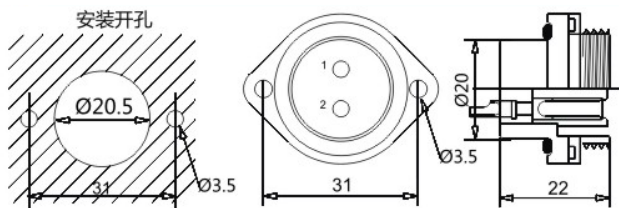

方盘法兰插座: ZG

Square flange panel receptacle: ZG

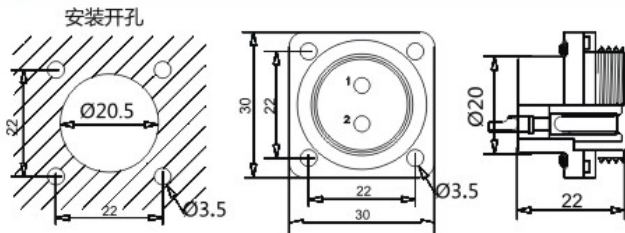

电缆对接插座: ZP

In-line cable receptacle with hose gland: ZP

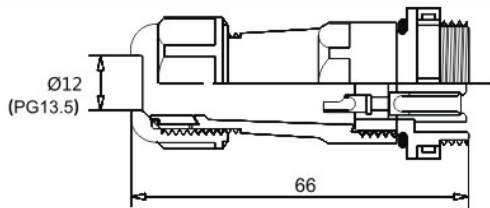

直式软管插座: ZR

In-line cable receptacle with cable gland: ZR

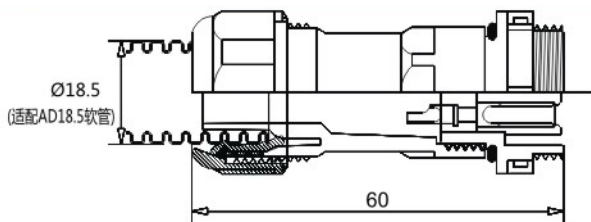

插头 Plug

弯式电缆插头: TA

90° angled plug with cable gland: TA

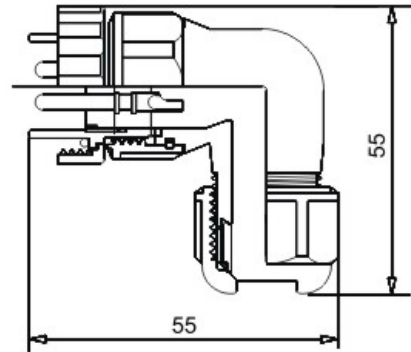

弯式软管插头: TC

90° angled plug with hose gland: TC

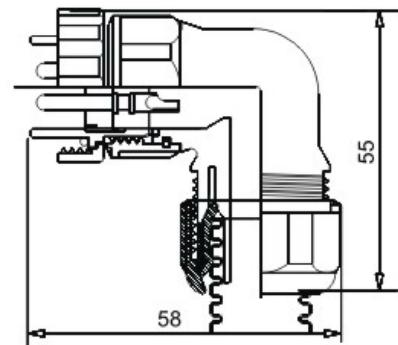

直式电缆插头: TP

Straight plug cable gland: TP

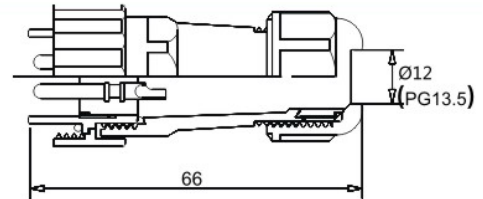

直式软管插头: TR

Straight plug hose gland: TR

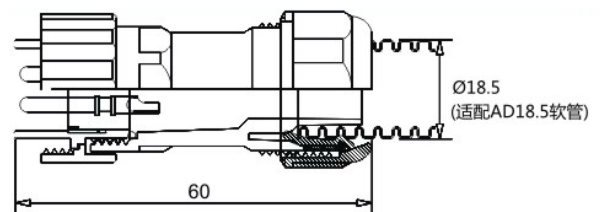

MA28 系列

插座 Receptacle

插头 Plug

后螺母插座: ZM

Round flange panel receptacle: ZM

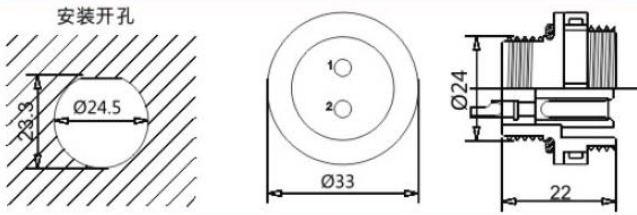

2 孔法兰插座: ZS

2-hole flange receptacle: ZS

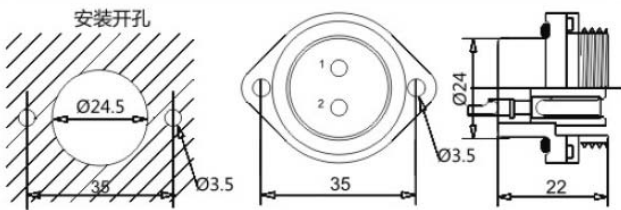

方盘法兰插座: ZG

Square flange panel receptacle: ZG

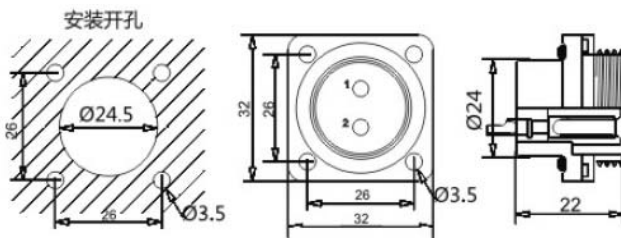

电缆对接插座: ZP

In-line cable receptacle with hose gland: ZP

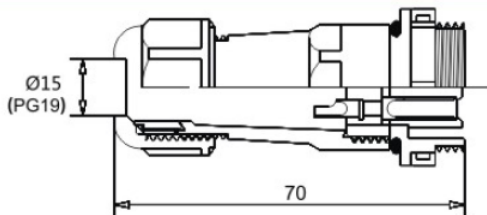

直式软管插座: ZR

In-line cable receptacle with cable gland: ZR

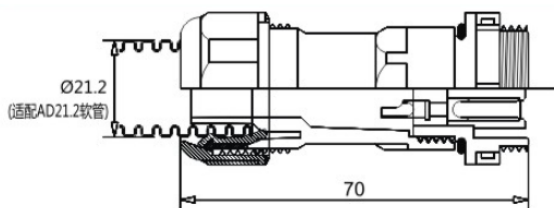

弯式电缆插头: TA

90° angled plug with cable gland: TA

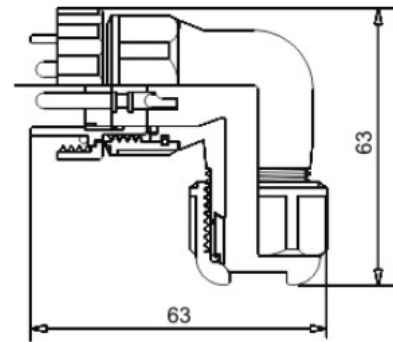

弯式软管插头: TC

90° angled plug with hose gland: TC

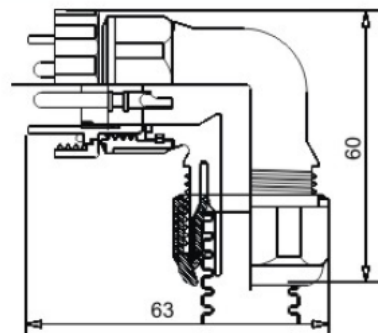

直式电缆插头: TP

Straight plug cable gland: TP

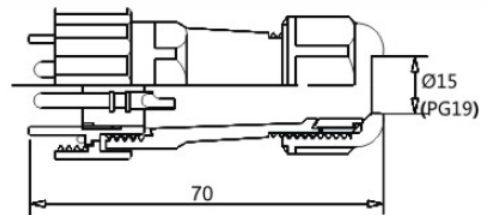

直式软管插头: TR

Straight plug hose gland: TR

